

564 HO GreenSmart™ Fireplace

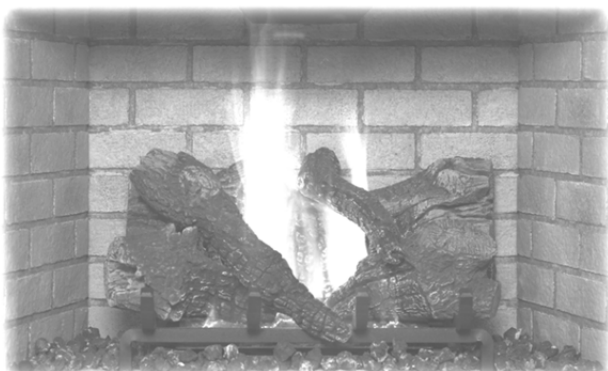

Listed by



AS 4553-2008

GMK10022

IAPMO-R&T OCEANA

Operation - Maintenance

WARNING: If the information in these instructions is not followed exactly, a fire or explosion may result causing property damage, personal injury or loss of life.

- Do not store or use gasoline or other flammable vapors and liquids in the vicinity of this or any other appliance.

WHAT TO DO IF YOU SMELL GAS:

- Do not try to light any appliance.
- Do not touch any electrical switch; do not use any phone in your building.
- Immediately call gas supplier from a neighbor's phone. Follow the gas supplier's instructions.
- If you cannot reach your gas supplier, call the fire department.
- Installation and service must be performed by a qualified installer, service agency or the gas supplier.

This appliance may be installed in an aftermarket permanently located, manufactured home (USA only) or mobile home, where not prohibited by local codes.

This appliance is only for use with the type(s) of gas indicated on the rating plate. A conversion kit is supplied with the appliance.

WARNING

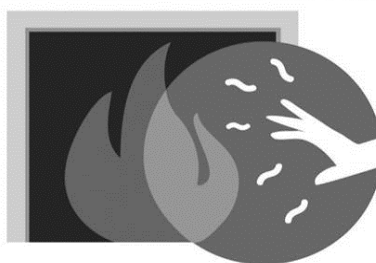

**HOT GLASS WILL CAUSE BURNS.
DO NOT TOUCH GLASS UNTIL COOLED.
NEVER ALLOW CHILDREN TO TOUCH GLASS.**

Owner's Manual

Dragon Wholesaling Pty. Ltd.
Unit 2, 16 Lexington Drive
Bella Vista NSW 2153
Australia

Introduction

We welcome you as a new owner of a 564 HO gas fireplace. This manual details operation and maintenance of this fireplace. Please familiarize yourself with the Owner's Manual before operating your heater and save the manual for future reference.

Important Information

No other 564 HO gas fireplace has the same serial number as yours. The serial number is on the listing label that is chained to the gas control valve. This serial number may be needed in case you require service.

Model: 564 HO GS Fireplace

Serial Number: _____

Purchase Date: _____

Purchased From: _____

Register your warranty online at:

lopi.com.au

Or, mail your warranty card to:

**Dragon Wholesaling Pty. Ltd.
 Unit 2, 16 Lexington Drive
 Bella Vista NSW 2153
 Australia**

Save Your Bill of Sale.

To receive full warranty coverage, you will need to show evidence of the date you purchased your heater. Do not mail your Bill of Sale to us.

We suggest that you attach your Bill of Sale to this page so that you will have all the information you need in one place should the need for service or information occur.

Installation Warnings

- **Installation requirements are printed in the 564 HO Installation Manual (part # 100-01263). All requirements in the installation manual must be met.**
- **Failure to follow all of the requirements may result in property damage, bodily injury, or even death.**
- **This heater must be installed by a qualified installer who has gone through a training program for the installation of direct vent gas appliances.**
- **This appliance must be installed in accordance with all local codes, if any; if not, follow ANSI Z223.1 and NFPA 54(88).**
- **In Manufactured or Mobile Homes must conform with Manufactured Home Construction and Safety Standard, Title 24 CFR, Part 3280, or, when such a standard is not applicable, the Standard for Manufactured Home Installations, ANSI/NCSCS A225.1. This appliance may be installed in Manufactured Housing only after the home is site located.**
- **The fireplace is designed to operate on natural gas, or propane (LP).**
- **All exhaust gases must be vented outside the structure of the living-area. Combustion air is drawn from outside the living-area structure.**
- **Notify your insurance company before hooking up this fireplace.**

Table of Contents

Introduction and Important Information

Introduction 2
 Important Information 2
 Installation Warnings 2
 Features 3
 Heating Specifications 3

Safety Precautions

Safety Precautions 4

Operation

Before You Begin 6
 Location of Controls 6
 Starting the Fireplace for the First Time 7
 Turning the Fireplace On and Off 7
 Comfort Control 7
 Adjusting the Flame Height 8
 Accent Light 8
 Adjusting the Blower Speed 9
 Continuous Pilot / GreenSmart™ Pilot Switch 9
 Normal Operating Sounds 10
 Normal Operating Odors 10

Maintenance

Maintaining Your Fireplace's Appearance 11
 Battery Replacement 11
 Accent Light Replacement 12
 Yearly Service Procedure 14
 Grill Installation and Removal 15
 Face Installation and Removal 16
 Glass Frame Removal and Installation 17
 Glass Cleaning 19
 Troubleshooting Table 20
 Wiring Diagram 21
 Replacement Parts List 22

Warranty

Warranty 29

Optional Equipment

Optional Equipment List 24

Index

Index 26

Features

- Works During Power Outages (battery backup)
- Optional GreenSmart™ Thermostat / Remote Control
- Realistic "Wood Fire" Look
- Standard Blowers for Effective Heat Distribution
- Built-In Accent Light (night light)
- Built-In Control Panel Light
- Standing or Intermittent (GreenSmart) Pilot
- Convenient Operating Controls
- Variable-Rate Heat Output
- Low Maintenance

Heating Specifications

	Natural Gas	Propane
Approximate Heating Capacity (in square meters)*	Up to 158	Up to 158
Maximum MJ Input Per Hour	35.0	35.0

* Heating capacity will vary with floor plan, insulation, and outside temperature.

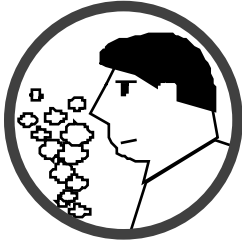

IF YOU SMELL GAS:

- * Do not light any appliance
- * Extinguish any open flame
- * Do not touch any electrical switch or plug or unplug anything
- * Open windows and vacate building
- * Call gas supplier from neighbor's house, if not reached, call fire department



This unit must be installed by a qualified installer to prevent the possibility of an explosion. Your dealer will know the requirements in your area and can inform you of those people considered qualified. The room heater should be inspected and cleaned before use and at least annually by a qualified service person. More frequent cleaning may be required due to excessive lint from carpeting, bedding material, etc.

The instructions in this manual must be strictly adhered to. Do not use makeshift methods or compromise in the installation. Improper installation will void the warranty and safety listing.

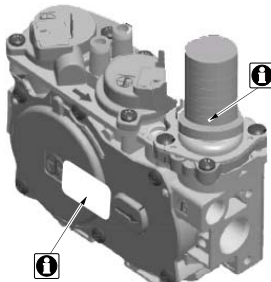

This heater is either approved for natural gas (NG) or for propane (LP). Burning the incorrect fuel will void the warranty and safety listing and may cause an extreme safety hazard. Direct questions about the type of fuel used to your dealer. Check for a label on the flame adjust knob on the gas control valve (this is the best place to check). You may also check for a label on the gas control valve body.



Contact your local building officials to obtain a permit and information on any installation restrictions or inspection requirements in your area. Notify your insurance company of this heater as well.



If the flame becomes sooty, dark orange in color, or extremely tall, do not operate the heater. Call your dealer and arrange for proper servicing.

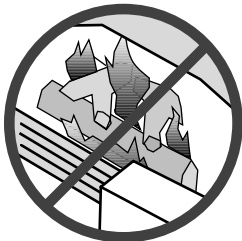

It is imperative that control compartments, screens, or circulating air passageways of the heater be kept clean and free of obstructions. These areas provide the air necessary for safe operation.



Do not operate the heater if it is not operating properly in any fashion or if you are uncertain. Call your dealer for a full explanation of your heater and what to expect.



Do not store or use gasoline or other flammable liquids in the vicinity of this heater.



Do not operate if any portion of the heater was submerged in water or if any corrosion occurs. Immediately call a qualified service technician to inspect the appliance and to replace any part of the control system and any gas control that has been under water.



Do not place clothing or other flammable items on or near the heater. Because this heater can be controlled by a thermostat there is a possibility of the heater turning on and igniting any items placed on or near it.

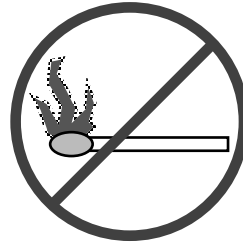

Light the heater using the built-in igniter. Do not use matches or any other external device to light your heater.



The viewing glass should be opened only for conducting service. Do not operate with cracked, broken, or removed glass.

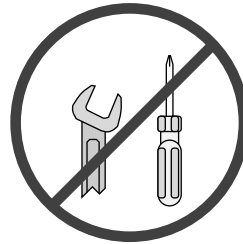

Never remove, replace, modify or substitute any part of the heater unless instructions are given in this manual. All other work must be done by a trained technician. Don't modify or replace orifices.



Operate the heater according to the instructions included in this manual.

If the main burners do not start correctly turn the gas off at the gas control valve and call your dealer for service.

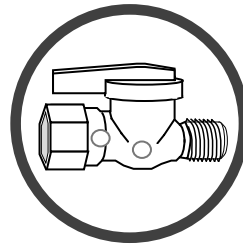

Instruct everyone in the house how to shut gas off to the appliance and at the gas main shutoff valve. The gas main shutoff valve is usually next to the gas meter or propane tank and requires a wrench to shut off.



This unit is not for use with solid fuel

Do not place anything inside the firebox (except the included fiber logs).

If the fiber logs become damaged, replace with Travis Industries log set.



Do not throw this manual away. This manual has important operating and maintenance instructions that you will need at a later time. Always follow the instructions in this manual.



Children and adults should be alerted to the hazards of high surface temperature and should stay away to avoid burns or clothing ignition. Young children should be supervised when they are in the same room as the heater.



Dragon Wholesaling grants no warranty, implied or stated, for the installation or maintenance of your heater, and assumes no responsibility of any consequential damage(s).

Before You Begin

- Read this entire manual before you use your new fireplace (especially the section "Safety Precautions" on pages 4 & 5). Failure to follow the instructions may result in property damage, bodily injury, or even death.

Location of Controls

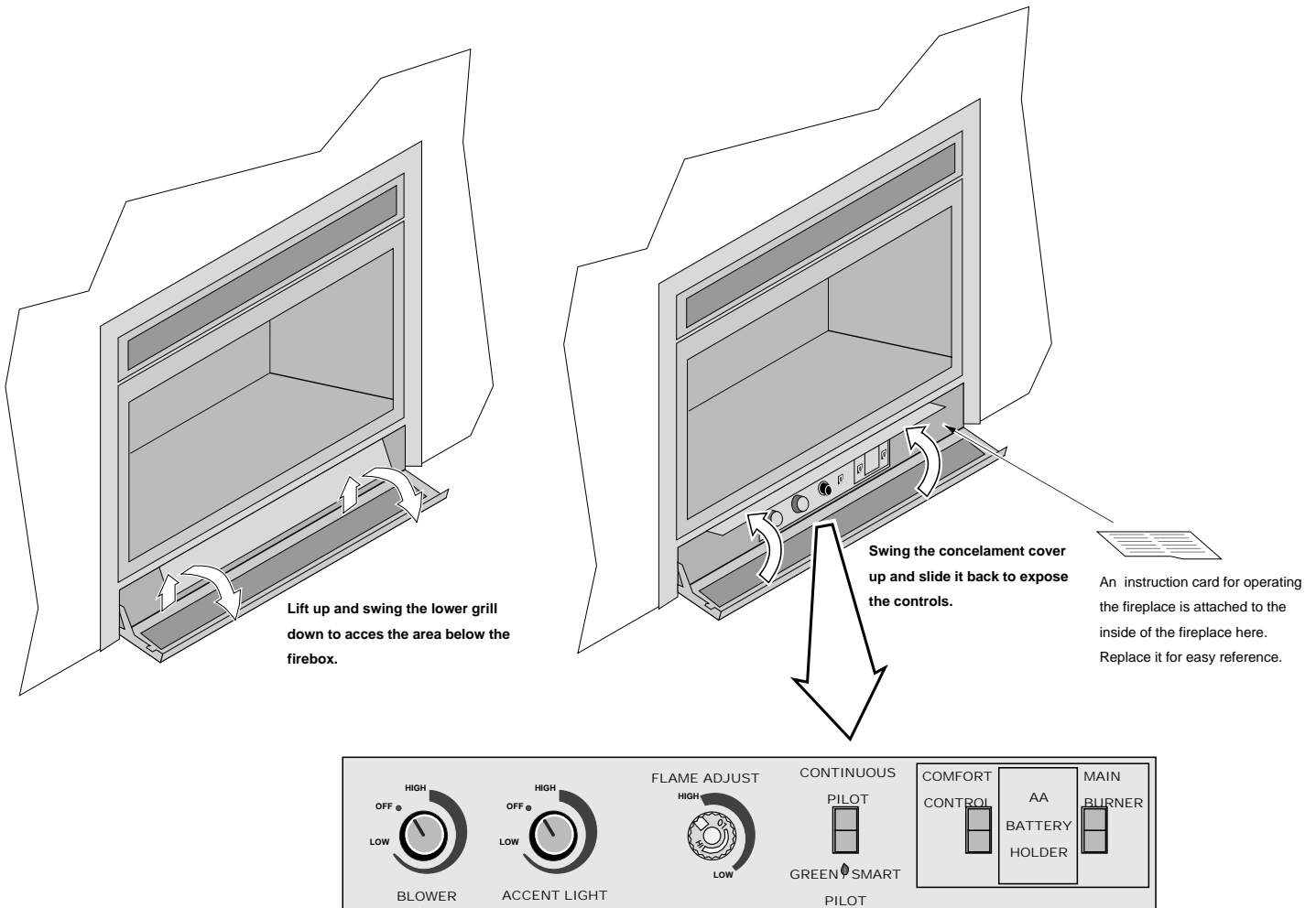

Blower Control	This knob controls the speed of the internal convection blower that pushes heated air into the room.
Accent Light	This knob controls the accent lights located behind the logs.
Flame Adjust Knob	This knob controls the flame height from low ("LO") to high ("HI").
Continuous Pilot -- GreenSmart Pilot	This switch controls how the pilot flame works. See the section "Continuous Pilot / GreenSmart Pilot" for details.
Comfort Control	This switch turns the rear burner on and off.
AA Battery Holder	This holder contains 4 AA batteries that allow the fireplace to operate during power outages.
Main Burner	This switch turns the fireplace burners on and off.

Starting the Fireplace for the First Time

- Burn the heater at a high setting with the blower off for an extended period (up to 48 hours). This will cure the painted surfaces. **Fumes** from the paint curing and oil burning off the steel will occur. This is normal. We recommend opening a window to vent the room.
- **Condensation** may appear on the glass each time you start the fireplace - this is normal.
- **Blue Flames** will occur on the fireplace when it first comes on. After fifteen minutes the flames will turn a more realistic yellow and orange color.
- Certain installations use a remote, thermostat, or wall switch to turn the fireplace on and off. If this is the case, leave the ON/OFF switch "ON".
- Verify the power backup and control light batteries are installed (see page 11).

Turning the Fireplace On and Off

Use the main burner switch to turn the main burner on and off.

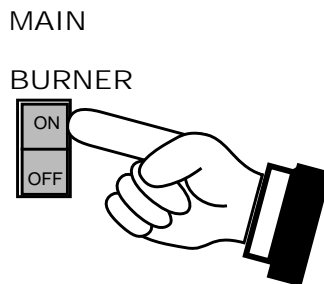

NOTE FOR REMOTES, THERMOSTATS, OR WALL SWITCHES:

The on/off switch on the fireplace may be required to be left in the ON or OFF position for the fireplace to operate. Consult your installer or dealer for details.

- Do not place any combustible items on top of or directly in front of the fireplace, even temporarily. An optional thermostat may start the fireplace causing a combustible item to ignite.
- If the fireplace turns on and off frequently while using the thermostat, you may want to adjust the flame height down until it produces just enough heat needed.

Comfort Control

The rear portion of the burner may be shut off to lower the heat output and flame size from the burner (this is called the comfort control). Use the comfort control switch to adjust this as desired.

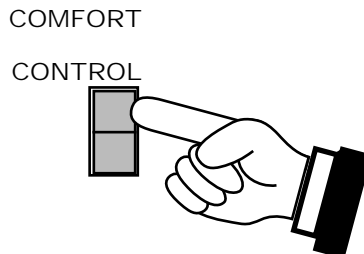

Adjusting the Flame Height

This fireplace has an adjustable flame to tailor the look and heat output to your specific needs. It is adjusted by turning the flame adjust knob.

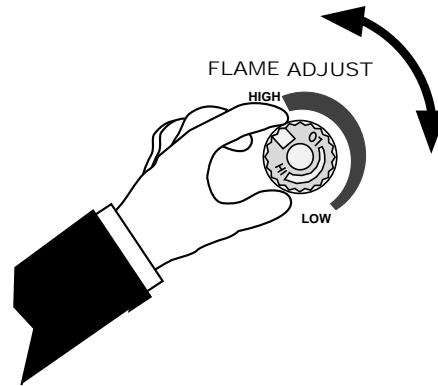

Accent Light

This fireplace has a built-in accent light that may be turned on and off and dimmed to your preference. Turn the knob to achieve the desired light output.

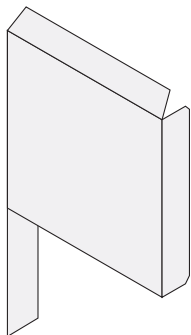
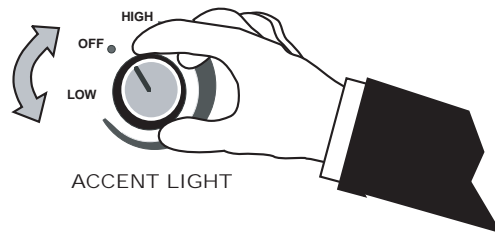

OFF

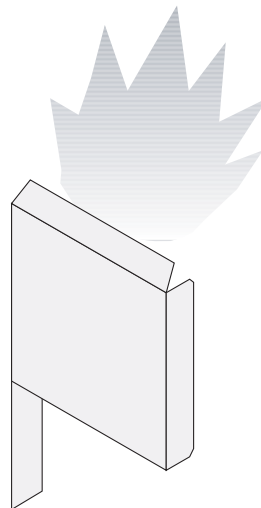

LOW

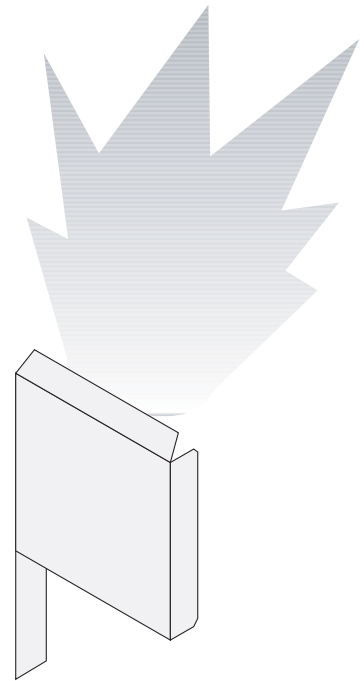

HIGH

Adjusting the Blower Speed

The blower helps transfer heat from the heater into the room. It will not turn on until the heater is up to temperature (approximately 15 minutes after starting). See the illustration below for instructions on adjusting the blower speed.

NOTE: With the rear burner off (comfort control), the heater may not become hot enough for the blower to turn on.

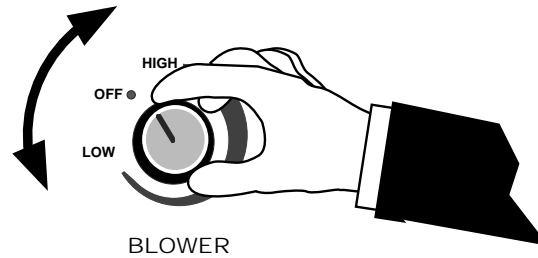

Continuous Pilot / GreenSmart™ Pilot Switch

This fireplace may run with the pilot continuously running or in GreenSmart (intermittent) mode. For most homeowners, the GreenSmart mode is preferred (this saves fuel, doesn't give off un-needed heat). However, in some situations the homeowner may prefer to switch the fireplace to continuous pilot. The most typical reasons for switching to continuous pilot are:

- Very Cold Conditions – in very cold conditions you may notice that the burner does not light quickly, and the flames lift off the burner. If this is situation, we recommend you switch to continuous pilot. This will create a slight draft in the vent, allowing for the burner to light quickly and draft correctly.
- Excessive Condensation on Glass After Startup – certain installations may encounter excessive fogging on the window after startup (not just the first time the fireplace was started). This is an aesthetic condition that may be remedied by switching the fireplace to continuous pilot.
- Cold Glass or Fireplace Front – in very cold conditions you may notice that the fireplace front and glass become very cold. To remedy this, switch the fireplace to continuous pilot.
- Frequent On / Off Operation – if you are frequently turning the fireplace on and off, you may wish to leave it in continuous pilot. This allows the burner to turn on more quickly, without pilot ignition delay.

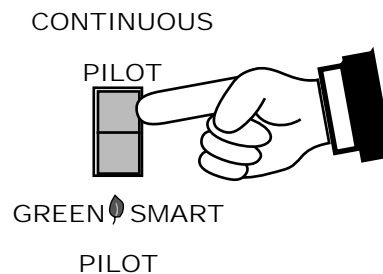

Normal Operating Sounds

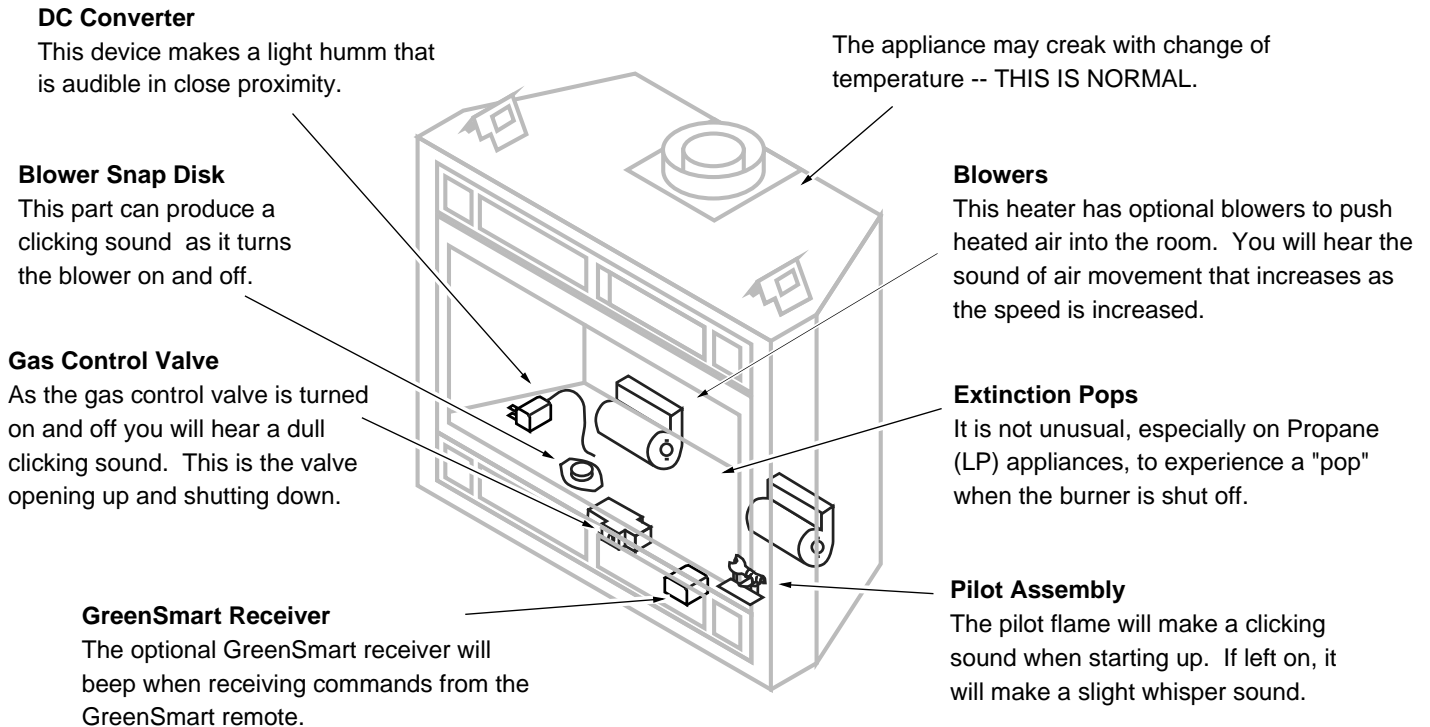

Normal Operating Odors

This appliance has several areas that reach high temperatures. Dust or other particles on these areas may burn and create an odor. This is normal during start-up. You may notice the smell is more acute if the appliance was left idle for a long period.

Maintaining Your Fireplace's Appearance

Fingerprints or other marks left on the optional plated surface may become etched in place if they are not wiped clean prior to turning the fireplace on. Clean the plated surface with denatured alcohol and a soft cloth (with the fireplace cool). Other cleaners may leave a film that may become etched into the surface.

Battery Replacement

Power Backup Batteries

Four AA batteries are used as a power backup for the fireplace in case the household (AC) power goes out. They also power the comfort control feature. These batteries must be inserted into battery holder (make sure they contact the terminals - see the illustration below). The fireplace controller will beep once these batteries start to go dead. Replace batteries before each heating season to insure proper operation.

Control Panel Light Battery

LED lights and a 9v battery are used to illuminate the control panel when the concealment cover is lifted. If the LED lights do not operate, replace the 9v battery (see the illustration below). The battery holder is held in place with Velcro and may be removed for easier access.

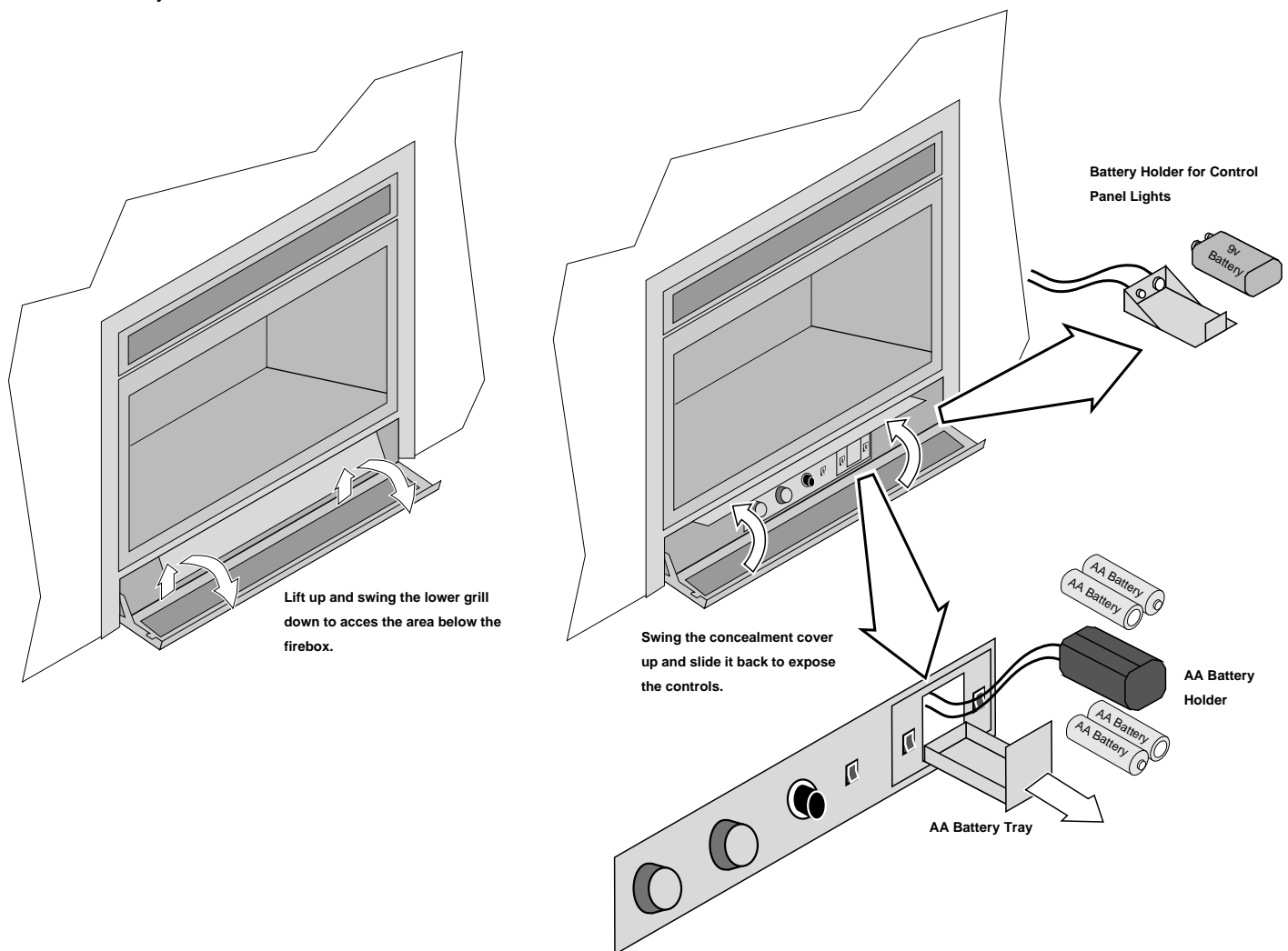

Accent Light Replacement

Accent lights are included in your fireplace to provide additional lighting. These bulbs will burn out over time. To replace, follow the directions below:

- Shut off gas to the fireplace and let it cool for 15 minutes.
- Turn off electricity to the fireplace (disable the breaker).
- Remove the glass (see page 17) and logs (see instructions included with logs).
- Replace the halogen bulbs with the following bulbs:

35 Watt 240 Volt T4 Halogen Bulb (G6.35 Base)

Lower Bulbs

- Located behind the logs on the EmberFyre and DancingFyre Burners.
- Located below the media tray (firebox floor) on the DiamondFyre Burner.

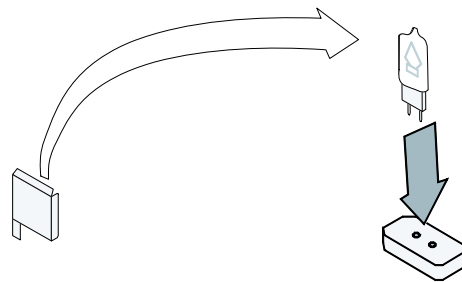

Remove the bulb from the socket as shown above.

(NOTE: .Take care to not touch the bulb with your fingers – use foam packing or paper towel to hold the bulb):

Upper Bulb

1. Remove the exhaust manifold from the roof of the fireback. The 2 rear screws are in slots, and do not need to be removed. Remove the 2 front screws from the exhaust manifold, then tilt the manifold down and slide it forward to remove.



- Remove the accent light cover plate from the roof of the firebox. Remove the outer 8 screws, not the inner 4 screws.

NOTE: When replacing this plate, position the glass to the rear. Make sure the gasket seals tightly against the firebox ceiling.



- Pull down the upper accent light enclosure from the roof of the firebox, as shown below. Note the 3 screws holding the bulb assembly in place.

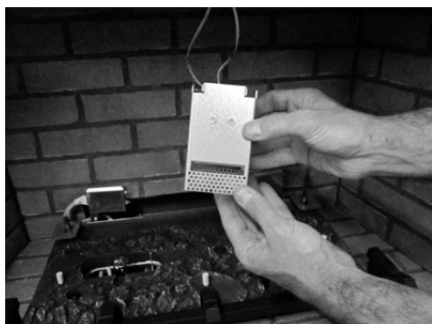

- Remove the 3 screws holding the bulb assembly in the accent light enclosure. Remove the bulb assembly from the enclosure.

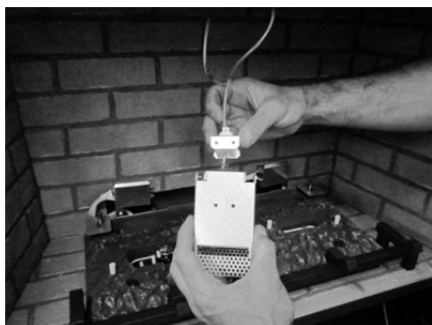

- Loosen the lower 2 set screws holding the bulb in place until the bulb becomes loose.

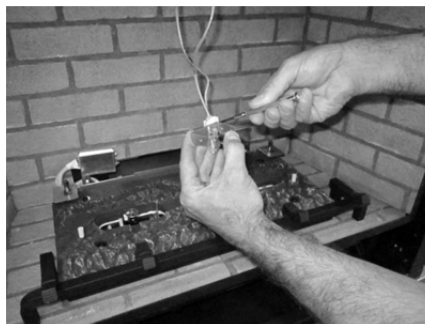

- Replace the bulb and tighten the set screws (do not over-tighten, this will damage the bulb).
(NOTE: Take care to not touch the bulb with your fingers – use foam packing or paper towel to hold the bulb):
- Return the fireplace to the correct configuration.

Yearly Service Procedure

Failure to inspect and maintain the fireplace may lead to improper combustion and a potentially dangerous situation. We recommend the following procedures be done by a qualified technician.

1. Turn the pilot flame to continuous. It should touch approximately 3/8" of the top of the flame sensor. If it does not, contact your dealer for service.
2. Shut off gas to the fireplace and let it cool for 15 minutes. Remove the glass (see page 17).
3. Remove the log set (**NOTE: The logs are very fragile** — see page 19). If severely deteriorated, replace. Check the logs for sooting. A small amount of soot along the bottom of the logs is normal. If excessive sooting is found, the fireplace will require adjustment. Contact your dealer.
4. Inspect the burner and remove any debris.
 - Make sure the burner is not warped, cracked, or damaged.
 - Check the firebox and area around the pilot to make sure there is no warping or damage.
 - If any problem is found, discontinue use and contact your dealer for service.
5. Replace the log set. Clean and replace the glass (see Glass Cleaning on page 19). If the glass is damaged, replace. Make sure the gasket along the perimeter of the glass contacts the face of the firebox and forms an air-tight seal. If it does not, re-align or replace the gasket to insure an air-tight seal.
6. Inspect the area behind the access door. Clean if necessary. Check the gas control valve and the gas lines. If damage is found, discontinue use and contact your dealer for service. Clean the air channels, ducts, and blower (if applicable).
7. Start the main burner. Inspect the main burner and pilot flame. After 15 minutes the flames should be orange/yellow and not touch the top of the firebox. If the pilot or main burners do not burn correctly, contact your dealer for service. Monitor blower operation.
8. Remove any debris or vegetation near the vent termination. Contact your dealer if any sooting or deterioration is found near the vent termination. Venting system should be examined by a qualified agency.

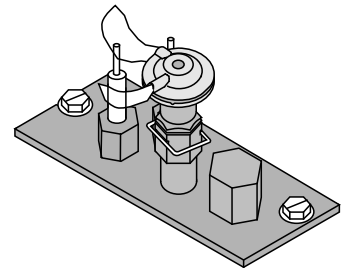

Grill Installation and Removal

Follow the directions below to install.

Upper Grill Installation (FPX and Avalon)

Hold the grill at an angle and insert the lower slot over the lower bushing on the fireplace (both sides)

Swing the grill upwards to engage the upper slot. You will need to lift the grill slightly to get it over the bushing. Once in place the grill is held in place by gravity.

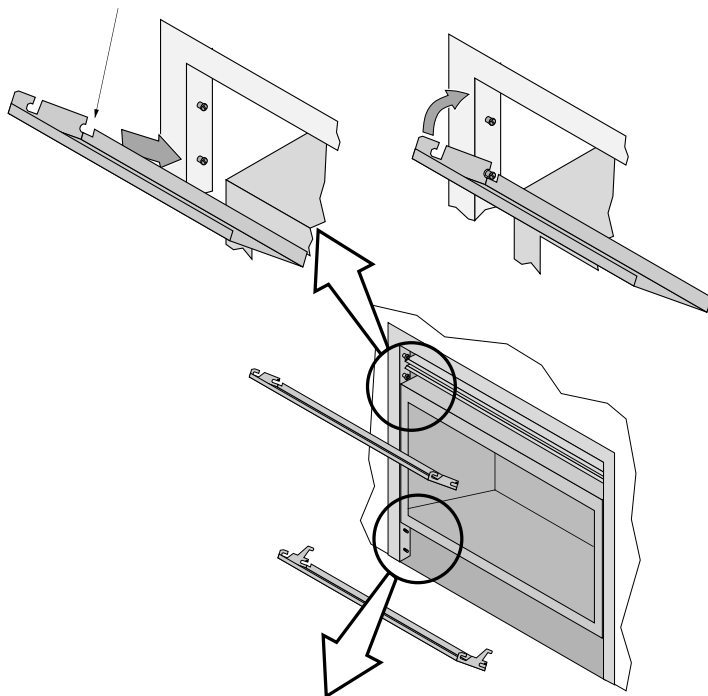

Lower Grill Installation

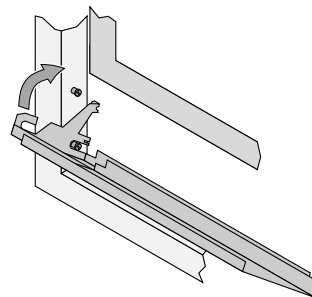
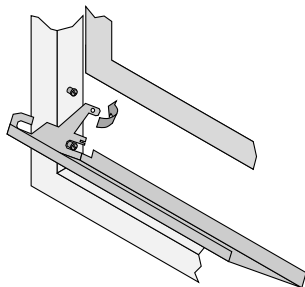
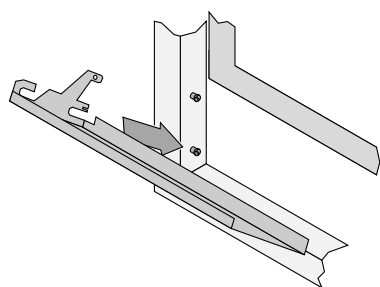

Hold the grill at an angle and insert the lower slot over the bushing on the fireplace (both sides). You may need press on the grill to get the tab over the bushing (this prevents the grill from accidentally falling off).

Bend the tab outward on both sides. This is the end-stop for the lower grill, it allows the grill to swing forward.

Swing the grill upwards to engage the upper slot. You will need to lift the grill slightly to get it over the bushing. Once in place the grill is held in place by gravity.

Upper Grill Installation (Lopi)

NOTE: The upper grill is difficult to install the first time - be patient, after you install it, you will know how it installs and it will be much easier the second time.

SIDE VIEW

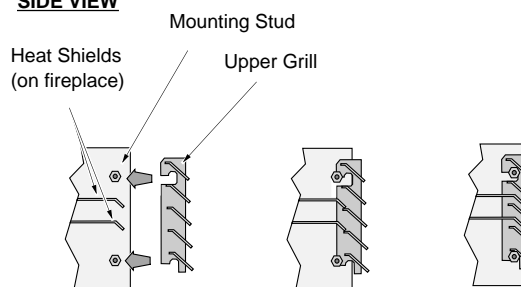

Position the grill so the slots on the grill align with the mounting studs.

You may need to push in and upwards on the grill as it inserts.

The grill, when fully inserted, will slide down and "click" into place.

Face Installation and Removal

Some fireplaces have a face that fits over the glass frame. The face can be removed following the directions below.

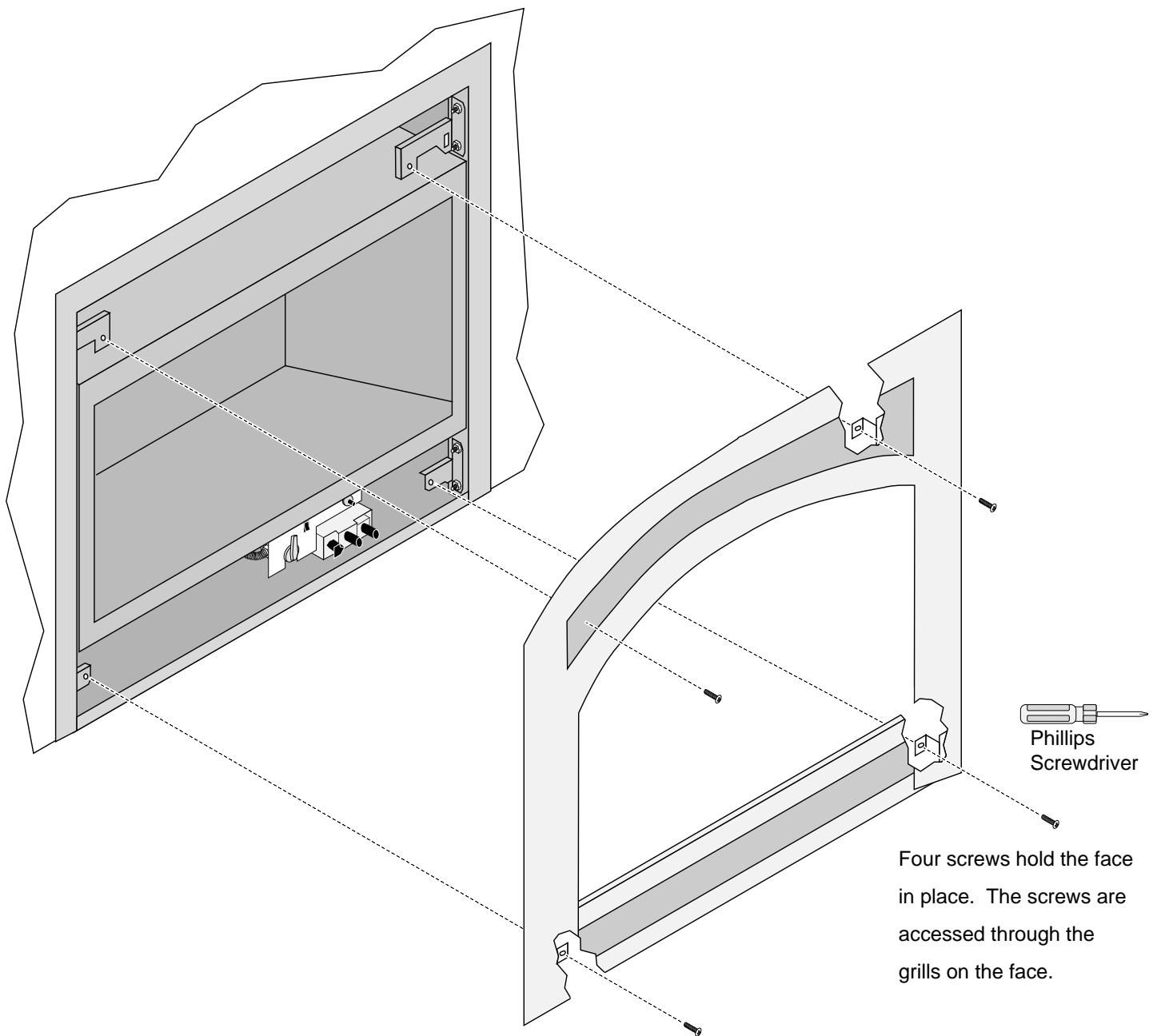

Glass Frame Removal and Installation

Warning: The appliance must be completely cool before removing the glass.

Warning: Do not strike or slam the glass.

- a** Depending on the face being used, either:
- 1) Swing the access door down and remove the top grill, or
 - 2) Remove the face by unscrewing it or lifting it off -- see the instructions included with the face for details.

Open the 4 latches holding the glass frame in place, starting with the bottom. Follow the instructions shown to the right.

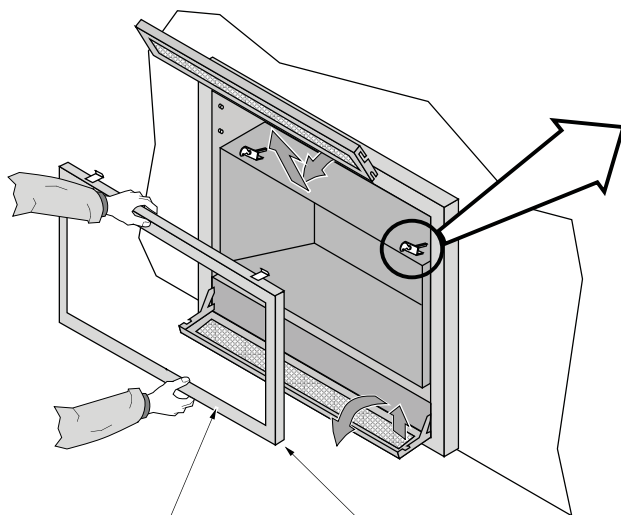

- b** Lift the glass frame up and pull it forward to remove.

NOTE:
You may need to lift the glass frame while re-attaching.

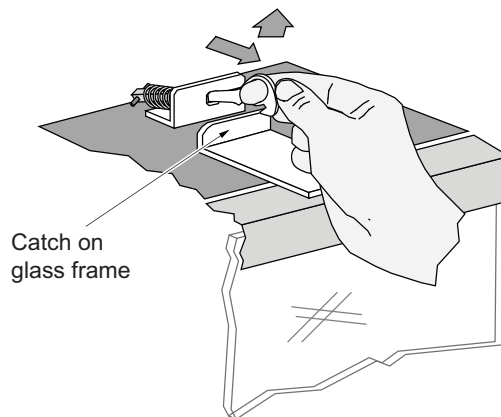
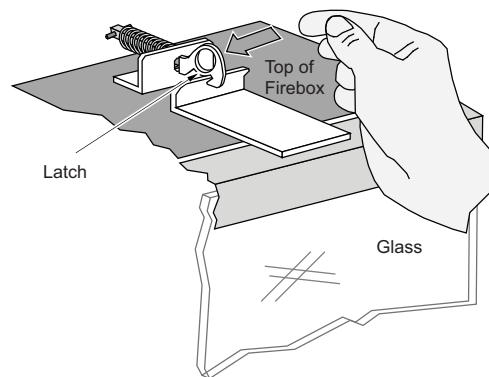

Re-Attaching the Glass Frame:

- 1) Hang the glass frame on the firebox.
- 2) While holding the frame in place, attach the upper latches (follow the instructions to the right in reverse).
- 3) Lift the glass frame slightly and attach the lower latches.

NOTE: Make sure the glass frame is fully in place -- it should be flush with the front of the fireplace when installed correctly.

Glass Frame Removal and Installation (continued)

The latch can come loose from the latch assembly. This occurs only when it is rotated. Follow the directions below to re-install the latch if it comes loose.

Hold the latch at an angle and insert it into the slot on the glass frame anchor.

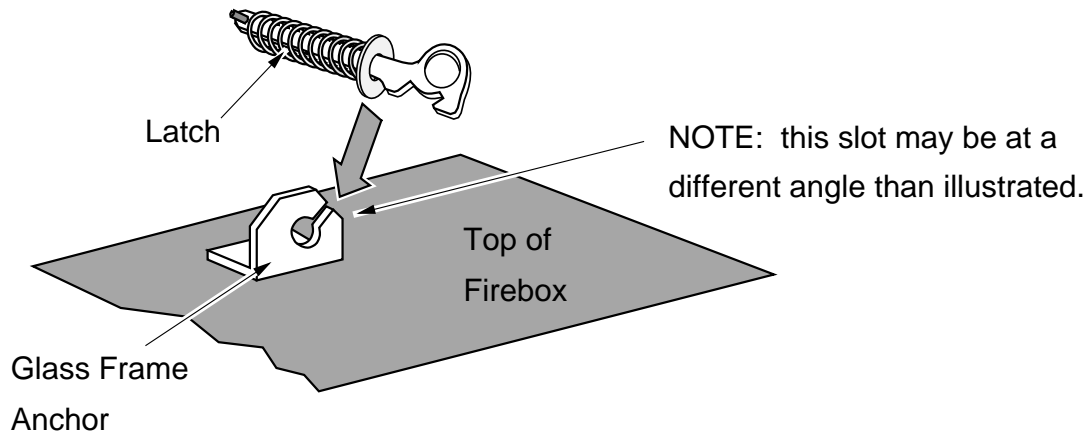

Note how the washer on the latch fits behind the flange on the glass frame anchor.

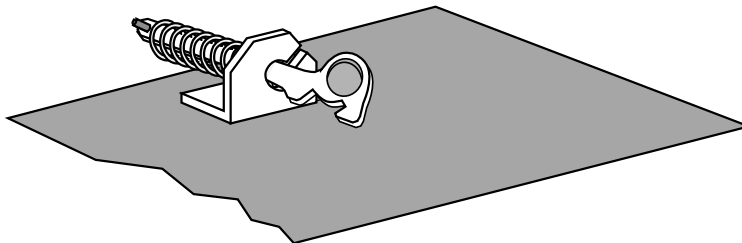

Once fully inserted, turn the latch until it is upright.

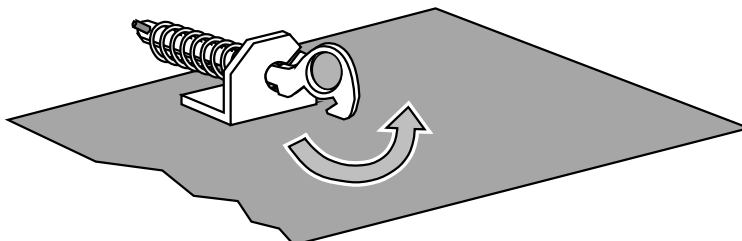

Log Set Installation

Log Set Overview

This fireplace has several log or media options. Refer to the instructions included with the logs or media for installation and removal.

Glass Cleaning

The glass may be cleaned with a non-abrasive cleaner.

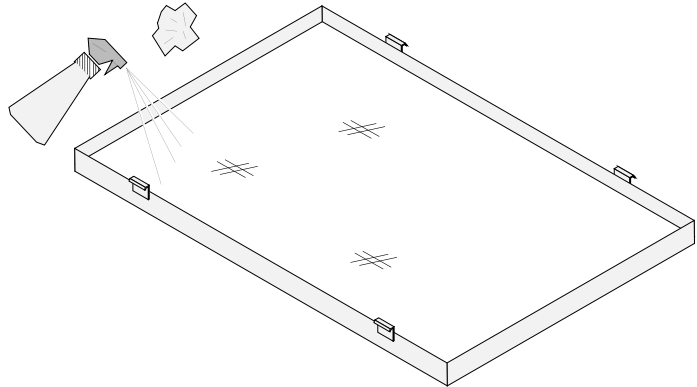

WARNING: do not operate the fireplace without the glass frame in place.

Troubleshooting Table

Problem:	Possible Cause:	Don't Call for Service Until You:
Main Burners Will Not Start	The ON/OFF switch is turned to "OFF" The remote control is not working correctly The thermostat is disconnected or set too low No Propane in Tank	Turn the ON/OFF switch to "ON" See the remote control instructions See "Thermostat Operation" Check Tank Level
Receiver Beeps	The power backup batteries are dead	Replace the batteries (see page 11)
Heater Beeps	The power backup batteries are dead (heater will beep once repeatedly) The heater encountered an error when trying to start (heater beeps 3 times repeatedly) The heater encountered a pilot error (heater beeps 2 times repeatedly)	Replace the batteries (see page 11) Make sure gas is turned on. Turn heater off for 5 seconds (make sure standing pilot is off) – then turn back on. Contact your dealer if this occurs.
Thermostat Does Not Work	The ON/OFF switch is turned to "OFF" The thermostat is set too low	Turn the ON/OFF switch to "ON" Check thermostat
Fireplace Will Not Distribute Heat	The fireplace is not getting electricity The fireplace is not up to temperature	Check the breaker switch Let the fireplace burn for at least 15 minutes
Flames Are Too Blue	The fireplace has just been started Improper air shutter adjustment	This is normal - see "Starting the Fireplace for the First Time" Adjust Air Shutter - contact your dealer
Flames Are Too Short (Under 6")	The flame height may be turned too low	Turn the flame height to "HI" - See "Adjusting the Flame Height"
Comfort Control Does not Work	The AA batteries may be dead	Replace the AA batteries (see page 11)
Thin Layer of Soot Covers the Glass	The logs or coals are placed incorrectly Improper air shutter adjustment	See "Log Set Installation" Adjust Air Shutter - contact your dealer

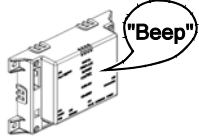

Wiring Diagrams

Stock Wiring Diagram

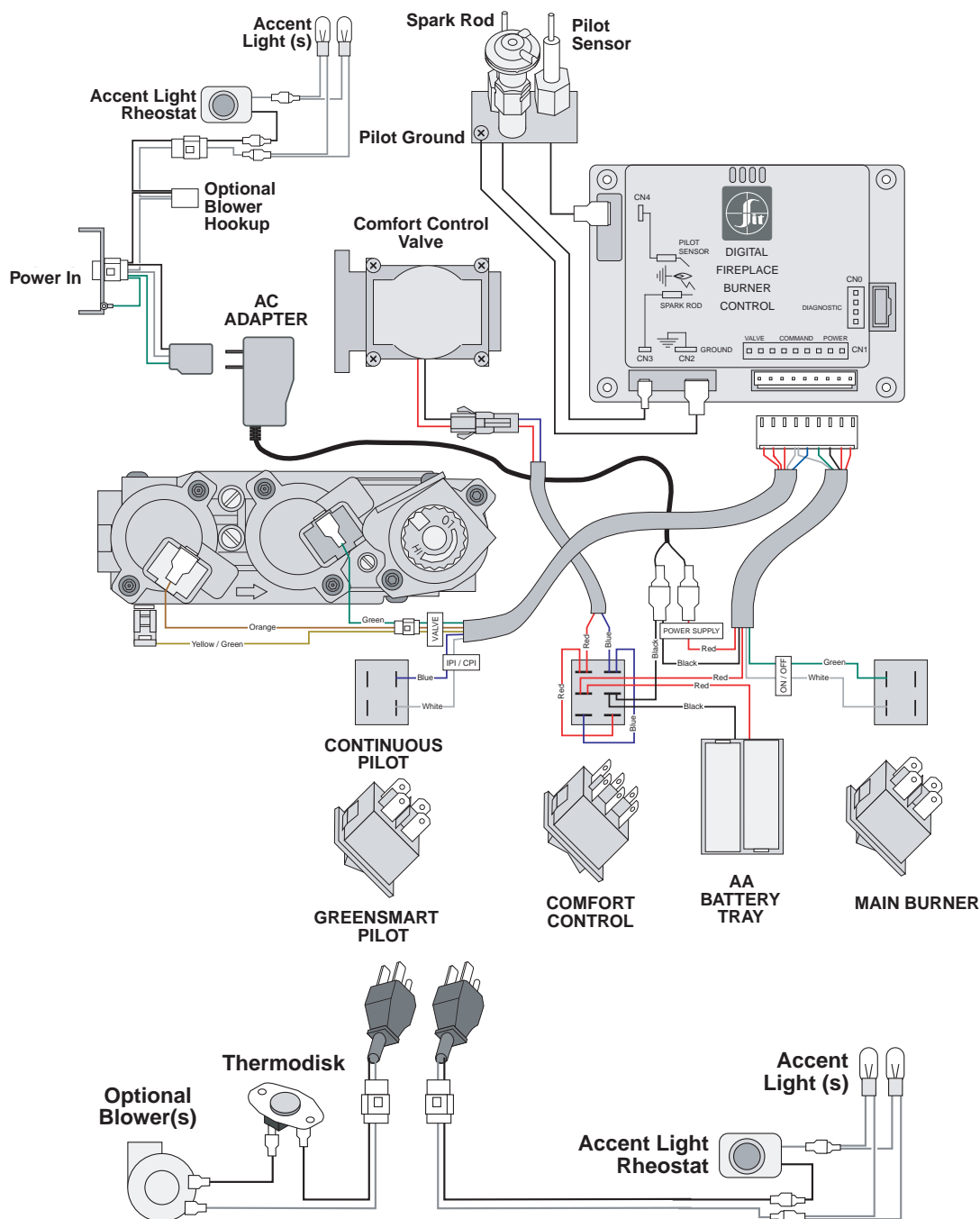

Caution: Label all wires prior to disconnection when servicing controls. Wiring errors can cause improper and dangerous operation.

GreenSmart Wiring Diagram

Caution: Label all wires prior to disconnection when servicing controls. Wiring errors can cause improper and dangerous operation.

Replacement Parts List

Caution: Use only Travis Industries replacement parts. Do not use substitute materials.

Warning: Do not operate appliance with the glass front removed, cracked, or broken. Replacement of the glass should be done by a licensed or qualified service person.

Register your **Dragon Wholesaling** Limited 7 Year Warranty online at lopi.com.au or complete the enclosed Warranty card and mail it within **ten (10)** days of the appliance purchase date to: Dragon Wholesaling Pty. Ltd. Unit 2, 16 Lexington Drive Bella Vista NSW 2153 Australia. **Dragon Wholesaling** warrants this gas appliance (appliance is defined as the equipment manufactured by Travis Industries, Inc.) to be defect-free in material and workmanship to the original purchaser from the date of purchase as follows:

**Check with your dealer in advance for any costs to you when arranging a warranty call.
Mileage or service charges are not covered by this warranty. This charge can vary from store to store.**

<u>Component</u>	<u>Years 1 & 2 Parts & Labor</u>	<u>Years 3 Through 5 Parts & Labor</u>	<u>Years 6 & 7 Parts Only</u>
<u>Burner Assembly</u> Burner Pan Assembly, Air Shutter Assembly, Main Burner Orifice	<input checked="" type="checkbox"/>		
<u>Electrical Assembly (within heater structure):</u> Wiring harness, snap discs, rheostat speed control	<input checked="" type="checkbox"/>		
<u>Gas Control Assembly</u> Adjustable control valve, fireplace controller, pilot assembly and pilot wiring	<input checked="" type="checkbox"/>		
<u>Glass</u> Glass (breakage from thermal shock)	<input checked="" type="checkbox"/>		
<u>Ceramic Logs</u> Log Set, Embers	<input checked="" type="checkbox"/>		
<u>Gold, Nickel & Copper Plating</u> Face & Door (see "Conditions and Exclusions" # 9)	<input checked="" type="checkbox"/>		
<u>Accessories</u> Firebacks, Andirons, etc.	<input checked="" type="checkbox"/>		
<u>One-Way Freight Allowance</u> One-way freight allowance on pre-authorized repair done at factory is covered.	<input checked="" type="checkbox"/>	<input checked="" type="checkbox"/>	
<u>Convection Heat Exchanger</u> Convection heat exchanger assembly	<input checked="" type="checkbox"/>	<input checked="" type="checkbox"/>	
<u>Firebox Assembly</u> Adjustable Air Restrictor, Pressure Relief Mechanisms, Glass Attachment Mechanism	<input checked="" type="checkbox"/>	<input checked="" type="checkbox"/>	<input checked="" type="checkbox"/>

EXCLUDED COMPONENTS:

Paint, Gasketing, and Accent Light Bulbs

CONDITIONS & EXCLUSIONS

- This new gas appliance must be installed by a qualified gas appliance technician. It must be installed, operated, and maintained at all times in accordance with the instructions in the Owner's Manual. Any alteration, willful abuse, accident, neglect, or misuse of the product shall nullify this warranty.
- This warranty is nontransferable, and is made to the ORIGINAL purchaser, provided that the purchase was made through an authorized DRAGON WHOLESALING dealer.
- Discoloration and some minor expansion, contraction, or movement of certain parts and resulting noise, is normal and not a defect and, therefore, not covered under warranty. The installer must ensure the appliance is burning as per the rating tag at the time of installation. Over-firing (operation above the listed BTU rate) of this appliance can cause serious damage and will nullify this warranty.
- The warranty, as outlined within this document, does not apply to the chimney components or other Non-Travis accessories used in conjunction with the installation of this product. If in doubt as to the extent of this warranty, contact your authorized DRAGON WHOLESALING retailer before installation.
- Dragon Wholesaling will not be responsible for inadequate performance caused by environmental conditions such as nearby trees, buildings, roof tops, wind, hills or mountains or negative pressure or other influences from mechanical systems such as furnaces, fans, clothes dryers, etc.
- This Warranty is void if:
 - The unit has been operated in atmospheres contaminated by chlorine, fluorine or other damaging chemicals.
 - The unit is subject to submersion in water or prolonged periods of dampness or condensation.
 - Any damage to the unit, combustion chamber, heat exchanger or other components due to water, or weather damage which is the result of, but not limited to, improper chimney/venting installation.
- Exclusions to this 7 Year Warranty include: injury, loss of use, damage, failure to function due to accident, negligence, misuse, improper installation, alteration or adjustment of the manufacturer's settings of components, lack of proper and regular maintenance, damage incurred while the appliance is in transit, alteration, or act of God.
- This 7 Year warranty excludes damage caused by normal wear and tear, such as paint discoloration or chipping, worn or torn gasketing, corroded or cracked logs, embers, etc. Also excluded is damage to the unit caused by abuse, improper installation, modification of the unit, drilling of the orifices, or the use of fuel other than that for which the unit is configured. Units are shipped for natural gas and must be converted to propane using the included conversion kit. Confirm fuel configuration with your installer.
- Damage to gold or nickel surfaces caused by fingerprints, scratches, melted items, or other external sources left on the gold or nickel from the use of cleaners other than denatured alcohol is not covered in this warranty.
- DRAGON WHOLESALING is free of liability for any damages caused by the appliance, as well as inconvenience expenses and materials. Incidental or consequential damages are not covered by this warranty. In some states, the exclusion of incidental or consequential damage may not apply.
- This warranty does not cover any loss or damage incurred by the use or removal of any component or apparatus to or from the gas appliance without the express written permission of DRAGON WHOLESALING and bearing a DRAGON WHOLESALING label of approval.
- Any statement or representation of DRAGON WHOLESALING products and their performance contained in DRAGON WHOLESALING advertising, packaging literature, or printed material is not part of this 7 year warranty.
- This warranty is automatically voided if the appliance's serial number has been removed or altered in any way. If the appliance is used for commercial purposes, it is excluded from this warranty.
- No dealer, distributor, or similar person has the authority to represent or warrant DRAGON WHOLESALING products beyond the terms contained within this warranty. DRAGON WHOLESALING assumes no liability for such warranties or representations.
- Dragon Wholesaling will not cover the cost of the removal or re-installation of hearths, facing, mantels, venting or other components.
- If for any reason any section of this warranty is declared invalid, the balance of the warranty remains in effect and all other clauses shall remain in effect.
- THIS 7 YEAR WARRANTY IS THE ONLY WARRANTY SUPPLIED BY DRAGON WHOLESALING. THE MANUFACTURER OF THE APPLIANCE. ALL OTHER WARRANTIES, WHETHER EXPRESS OR IMPLIED, ARE HEREBY EXPRESSLY DISCLAIMED AND PURCHASER'S RECOURSE IS EXPRESSLY LIMITED TO THE WARRANTIES SET FORTH HEREIN.**

IF WARRANTY SERVICE IS NEEDED:

- If you discover a problem that you believe is covered by this warranty, you **MUST REPORT** it to your DRAGON WHOLESALING dealer **WITHIN 30 DAYS**, giving them proof of purchase, the purchase date, and the model name and serial number.
- Dragon Wholesaling has the option of either repairing or replacing the defective component.
- If your dealer is unable to repair your appliance's defect, he may process a warranty claim through DRAGON WHOLESALING, including the name of the dealership where you purchased the appliance, a copy of your receipt showing the date of the appliance's purchase, and the serial number on your appliance. At that time, you may be asked to ship your appliance, freight charges prepaid, to DRAGON WHOLESALING. DRAGON WHOLESALING, at its option, will repair or replace, free of charge, your DRAGON WHOLESALING appliance if it is found to be defective in material or workmanship within the time frame stated within this 7 year warranty. DRAGON WHOLESALING will return your appliance, freight charges (years 1 to 5) prepaid by DRAGON WHOLESALING, to your regional distributor, or dealership.
- Check with your dealer in advance for any costs to you when arranging a warranty call. Mileage or service charges are not covered by this warranty. This charge can vary from store to store.

Accessories

The accessories listed below are available at your Dragon Wholesaling dealer. To locate a dealer, visit:

www.lopi.com.au

GreenSmart™ Remote / Thermostat

This accessory allows for remote control of your fireplace (burner, flame height, accent light).. It has a built-in thermostat if you wish for automatic temperature control.

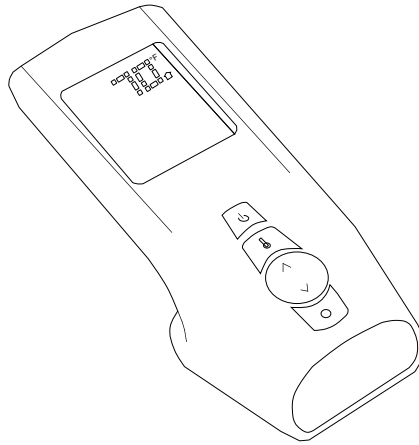

Index

Accent Light Replacement	12
Accent Light	8
Adjusting the Flame Height	8
Adjusting the Blower Speed	9
Battery Replacement	11
Before You Begin	6
Comfort Control	7
Continuous Pilot / GreenSmart™ Pilot Switch	9
Face Installation and Removal	16
Features	3
Glass Cleaning	19
Glass Frame Removal and Installation	17
Grill Installation and Removal	15
Heating Specifications	3
Important Information	2
Index	26
Installation Warnings	2
Introduction	2
Location of Controls	6
Maintaining Your Fireplace's Appearance	11
Normal Operating Odors	10
Normal Operating Sounds	10
Optional Equipment List	24
Optional Screen (on glass)	17
Replacement Parts List	22
Safety Precautions	4
Starting the Fireplace for the First Time	7
Troubleshooting Table	20
Turning the Fireplace On and Off	7
Warranty	27
Wiring Diagram	21
Yearly Service Procedure	14